



## Q caloric 5.5

Electronic device for heat cost allocation on the basis of measuring the share of heat output by radiators.

In terms of measuring technology, the Q caloric 5.5 is 100% compatible with the Q caloric 5. All assembly-related properties also match the Q caloric 5.

The Q caloric 5.5 has improved and extended wireless properties. Available as a compact and remote sensor variant.

## Application

---

The Q calorific 5.5 is the successor model to the tried-and-trusted Q calorific 5. In addition to improved energy management, the Q calorific 5.5 can be operated in different wireless modes. In terms of measuring technology, the Q calorific 5.5 is 100% compatible to the Q calorific 5. Installation instructions can be taken over from the Q calorific 5 without changes being necessary. Communication with the current software versions of the Q suite 5 calorific (V2.1 or higher) and ACT46 (V1.6 or higher) is possible without restrictions.

In S mode (walk-by & AMR), the Q calorific 5.5 is 100% compatible to the Q calorific 5. In C-mode (walk-by & OMS) the wireless capacities and ranges have been significantly improved compared to the Q calorific 5 in S-mode.

The electronic heat cost allocator Q calorific 5.5 has been designed for decentralised use. Values are measured through one (radiator) or two (radiator and room air temperature) temperature sensors. In 2-sensor operation the actual difference in temperature between the ambient temperature and the radiator temperature is determined, in 1-sensor operation a constant value is prescribed for the ambient temperature.

These measured values are used as a basis for calculation of the consumption calculation. The main area of application is in central heating systems where the heating energy is used individually by different consumers. The electronic heat cost allocator can be operated as a 1-sensor measuring system or 2-sensor measuring system with product and unit scale.

Such systems are used in e.g.:

- 】 Apartment buildings
- 】 Offices and administration buildings

Typical users are:

- 】 Meter reading service companies
- 】 Housing industry and housing associations
- 】 Building service companies and property management

The heat cost allocator can be used for the following types of radiator:

- 】 Ribbed radiators
- 】 Tubular radiators
- 】 Panel-type radiators with horizontal and vertical water flow
- 】 Radiators with internal tube register
- 】 Convector

## AMR

---

The electronic heat cost allocators Q calorific 5.5 type P2 and P3 are equipped with the AMR radio transmitter of the WHE4x device family.

The rcu4 radio system is not supported by the Q calorific 5.5.

## OMS

---

In C-mode the electronic heat cost allocator Q calorific 5.5 transmits OMS telegrams (OMS = Open Metering System) parallel to the walk-by telegrams. The OMS telegrams meet the "Open Metering System Specification" and can thus be received by all OMS-compatible devices.

## Data interface

---

The electronic heat cost allocators Q caloric 5.5 type P2 and P3 can be equipped with the IrDA close-range interface of the device family WHE3x/WHE4x.

The 1107 data interface is not supported by the Q caloric 5.5.

## Programming accessories

---

The programming accessories are used for communication with the metering devices.

### Programming adapter:

The programming adapter can be used as an individual programming tool and as a combi-adapter with the IrDA programming and readout head.

### IrDA programming and readout head(\*):

The IrDA programming and readout head is used as a communication tool between a PC/netbook and the meter. The meter can be programmed and read out using the Q suite 5 caloric (V2.1 or higher).

(\*) Only necessary for meters without an integrated IrDA close-range interface.

## Programming possibilities

---

The following information can be programmed before the measuring device is put into operation:

### Standard parameters

- 】 Sensor type  
1-sensor or 2-sensor measuring system
- 】 K-value / KC / KQ  
Evaluation factors for calculating radiator heat output  
(depending on the meter algorithm and sensor type)
- 】 Next due date  
Day the annual value is stored  
(can also be programmed without IrDA interface using the programming adapter)
- 】 Device name / device code  
Device access data as protection from unauthorised device access

## Displays

Device states, consumption values and measuring system information are displayed on the LCD in a display loop.

Display loops in normal operation:

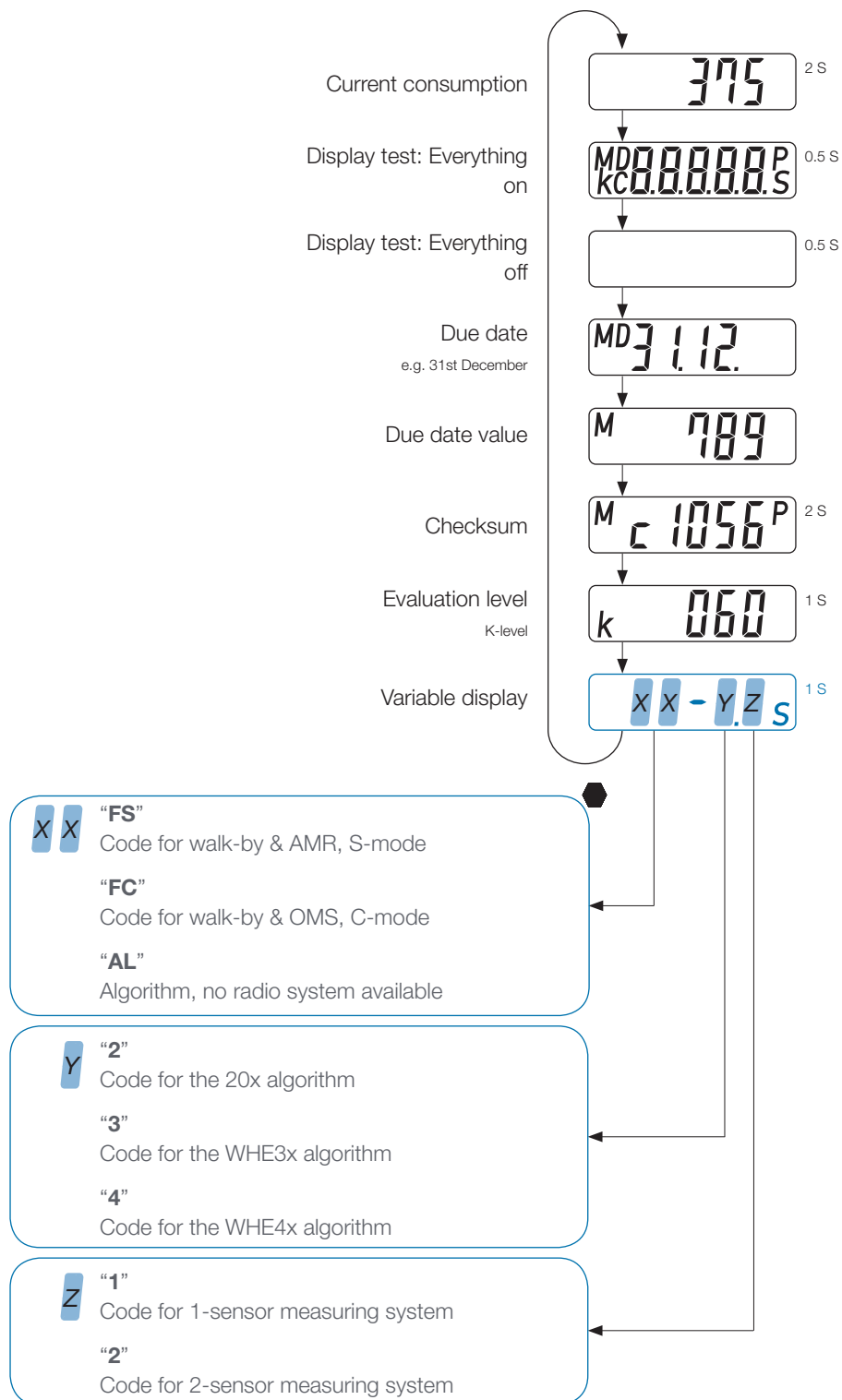

## Displays





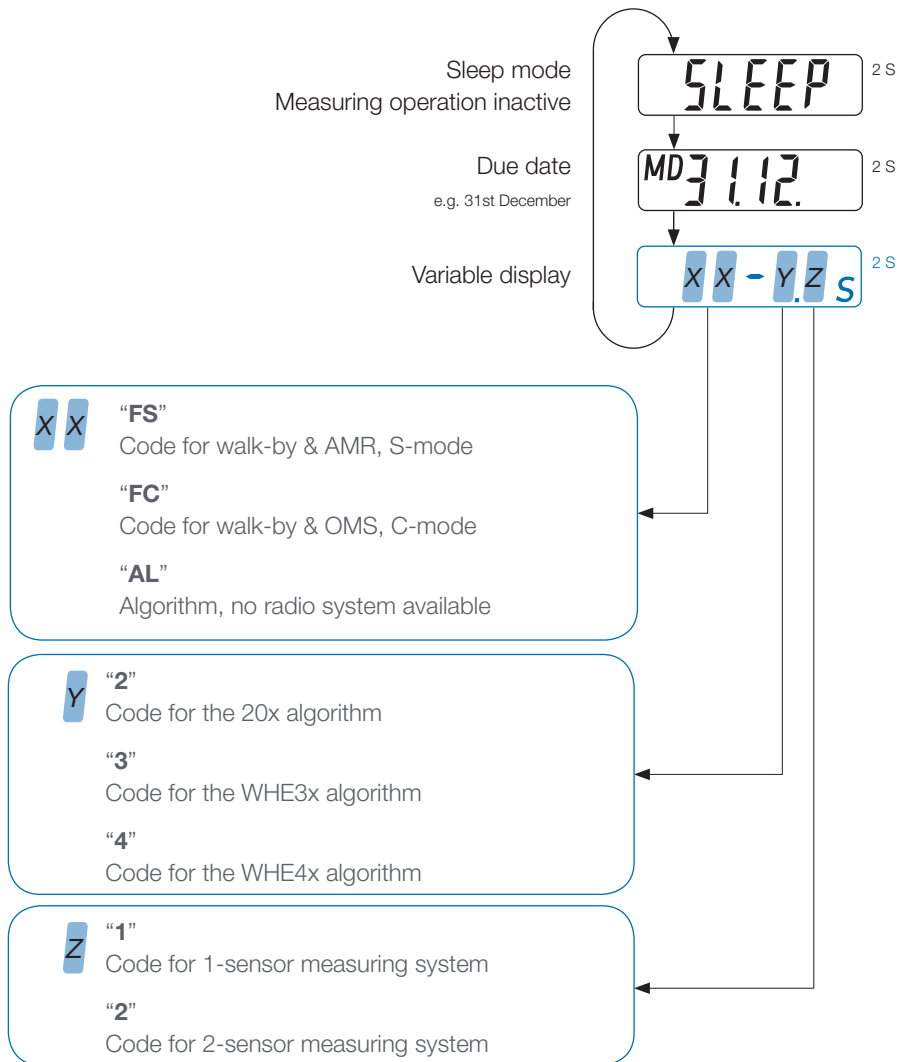







The meters are delivered from the factory in sleep mode. Measuring operation is inactive.

Device display loops in sleep mode

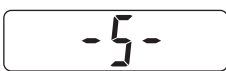

## Displays

### Special displays P2/P3

<p><b>Error messages</b> "Err 1" appears permanently. All other error messages are displayed in quick succession alternating with consumption values.</p>	 0.5 S 
<p><b>Consumption display suppressed</b> Is displayed in the event of an error in place of the invalid consumption values, depending on programming.</p>	 0.5 S 
<p><b>End of battery run time</b> Is displayed after the end of service life, alternating with the consumption values, depending on programming.</p>	 0.5 S 
<p><b>Manipulation or housing opening</b> Is displayed in the event of manipulation either as plain text alternating with the consumption values or by the indicator "c" shown discreetly on all displays, depending on programming.</p>	 0.5 S Plain text
<p>Example: Display "current value" with "c".</p>	 0.5 S discreet
<p><b>Data interface</b> (IrDA close-range interface) This display signals an active IrDA close-range interface.</p>	 10 S
<p><b>Radio system activated</b> S-mode: walk-by &amp; AMR C-mode: walk-by &amp; OMS The transmission of installation telegrams is indicated in this display. Display sequence: InSt8, InSt7, ... InSt1</p>	 30 S
<p><b>Commissioning</b> This display appears following clipping to the installation plate. Then the display changes to the normal mode display loop.</p>	 3 S
<p><b>Remote sensor code</b> The metering device has detected a remote sensor and adjusts its measuring behaviour accordingly.</p>	 3 S

## Radio (wireless) features S-mode

---

- 】 Radio system – parallel transmission of walk-by and AMR data telegrams
- 】 Transmission delay (offset)  
Time delay for sending telegrams after the due date or at the beginning of the moth in days (standard = 0 days)
- 】 Transmission-free day  
A maximum of 2 days from Friday, Saturday and Sunday can be defined as transmission-free days  
At least 1 day must be set (standard = Sunday).
- 】 No change with the remote sensor system

Transmission behaviour	
walk-by <sup>(*)</sup>	AMR
every 128 seconds	every 4 hours
10 hours per day (8 am - 6 pm)	24 hours per day
monthly: 4 readout dates after the first day of each month	7 days per week
annual: 48 hours after due date	365 days per year
current consumption values 13 Statistic values	data telegrams or statistics and consumption values

(\*) Compatible with Q caloric 5 / transmission delay or transmission-free days for walk-by only available in S-mode.

## Radio (wireless) features C-mode

---

- 】 Radio system – parallel transmission of walk-by and OMS data telegrams
- 】 Increased radio capacity in C-mode (10 dBm)
- 】 No change with the remote sensor system

Transmission behaviour	
walk-by <sup>(1)</sup>	OMS <sup>(2)</sup>
every 112 seconds	every 7.5 minutes
10 hours per day (8 am - 6 pm)	24 hours per day
365 days per year	365 days per year
current consumption values 13 Statistic values	current consumption values

(1) For this, you need the mobile data logger Q log 5.5 and the readout software ACT46.PC V1.6.

The readout software can be downloaded from <http://qdc.qundis.com>.

(2) OMS "Open Metering System" communication architecture for intelligent meters for different manufacturers and branches.

## Mode change

---

It is possible to change between S-mode and C-mode in both directions.

For this, you need the Q suite 5 caloric (V2.1 or higher), a programming adapter or an IrDA programming and readout head<sup>(\*)</sup>.

(\*) Only necessary for meters without an integrated IrDA close-range interface.

## Technical features

<b>Device data</b>	
Measuring system	as 1-sensor measuring system - with dynamic heating operation detection as 2-sensor measuring system - 1 sensor each for radiator and room air temperature
Device type	Q caloric 5.5 (P2) profile compatibility HKVE 20x Q caloric 5.5 (P3) profile compatibility WHEX
Power supply	3V lithium battery
Service life	typ. 10 years
Display	Liquid crystal display (LCD)
Scope of display	5 digits (00000 ... 99999)
Evaluation	Algorithm 2: K-values 1-sensor measuring system 255 values (basis: K-value 26) 2-sensor measuring system 999 values (basis: K-value 60)  Algorithm 3/4: Repair and extension installations Existing information in the system manual for the WHEX models
Radiator power range	21 Watt ... 9,999 Watt ...
Sensor temperature range	0 °C ... 105 °C
tm-max tm-min(*) (*) mean design temperature	105 °C (compact device), 105 °C (remote sensor device) 35 °C (2-sensor system), 55 °C (1-sensor system)
Temperature sensor	NTC, prematurely aged
Device versions	Compact device Remote sensor device (compact device with inserted remote sensor) Remote sensor cable lengths: 1.5 m, 2.5 m and 5.0 m
Installation material	New installation and conversion: Q caloric 5.5 with existing installation material  Standard replacement, extension installation and repair replacement: Q caloric 5.5 with installation material following the families HKVE 20x and WHE3x/WHE4x

<b>Norms and standards</b>	
Heat cost allocator for acquiring consumption data for room heating	DIN EN 834:2013
Type approval acc. to HKVO	A1.01.2011 - Q caloric 5.5 - P2 C3.01.2011 - Q caloric 5.5 - P3
CE conformity	Directive 2004/108/EC (Electromagnetic Compatibility)
	With radio support Directive 1999/5/EC (R&TTE Directive)



## Dimensioning drawing of the device

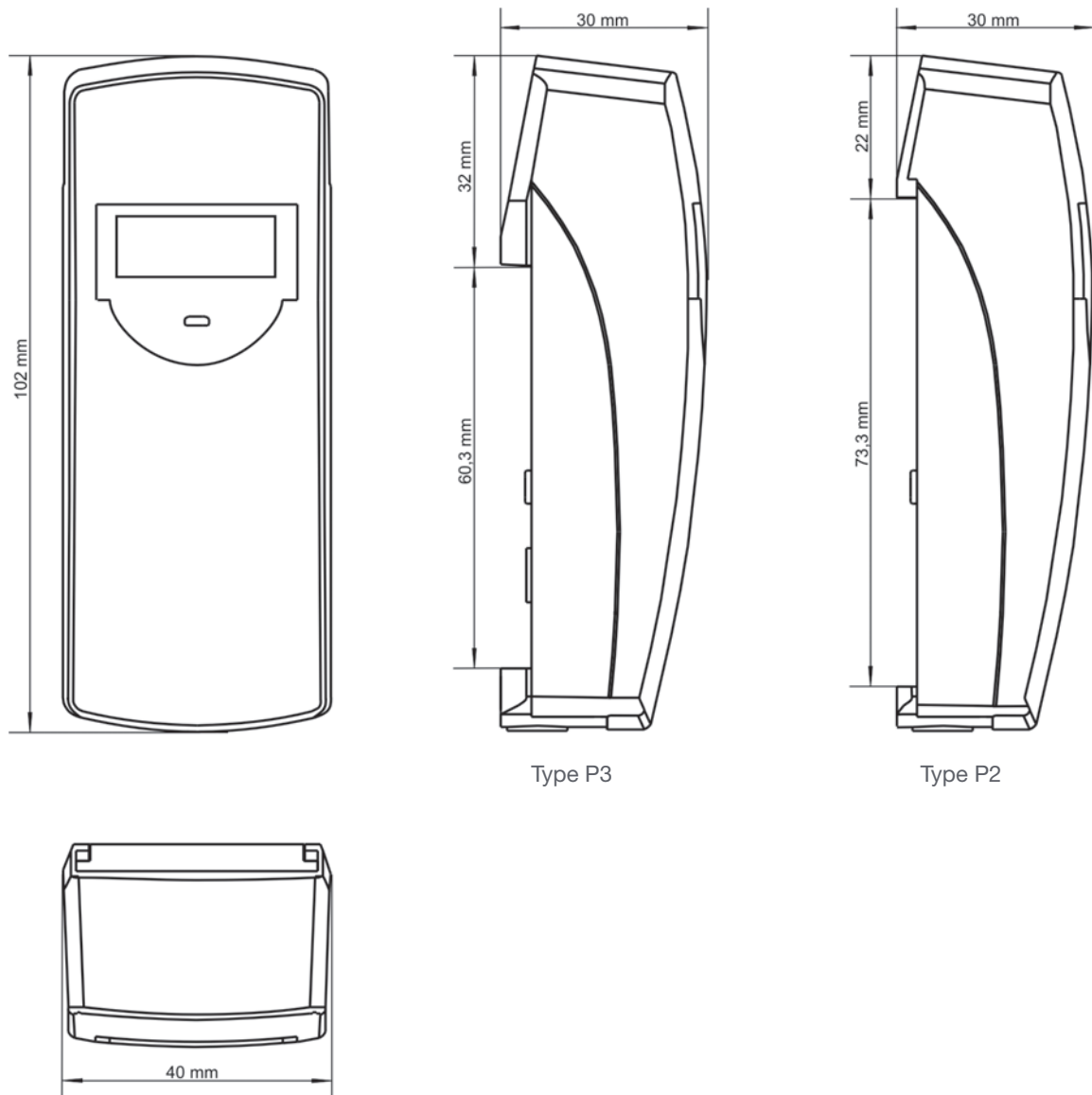

## Restrictions

Electronic heat cost allocators cannot be used with steam heaters, fresh-air radiators, underfloor heating, ceiling heating elements or flap-controlled radiators.

In the case of combined valve and flap-controlled radiators, metering devices may only be installed if the flap control unit has been removed or disabled in the "open" position.

Convectors that can change their output through an electric fan and towel heaters with an electric heating cartridge must not be fitted with electronic heat cost allocators unless the respective electric system has been removed or disabled.

1-sensor and 2-sensor metering system

A joint use of different metering device types is only allowed within a property as long as they all use a standard metering system and have a standard measuring algorithm.

### Compatibility

The 202R can NOT be replaced by the Q caloric 5.5 AMR since the radio transmitter fitted in the heat cost allocator is not compatible with the rcu4 system.

Equally, the WHE2 can NOT be replaced by the Q caloric 5.5, since both the measuring algorithm and the radio transmitter fitted in the heat cost allocator (with WHE26) are not compatible.

## Dimensioning drawing of the snap-on panel

---

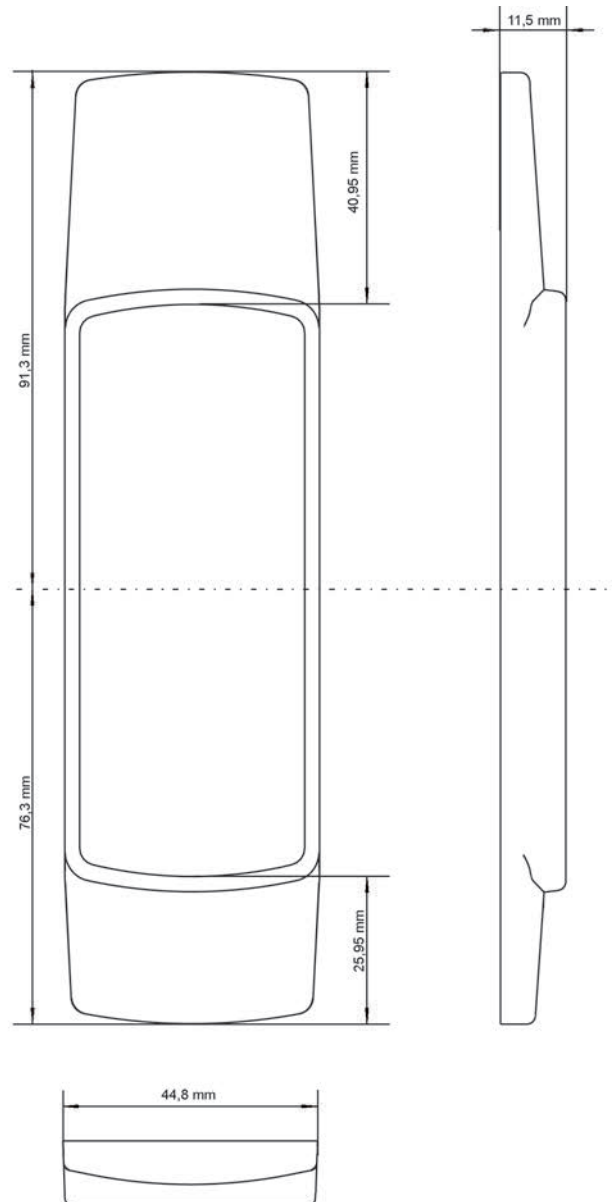

---

✉ **QUNDIS GmbH**  
Sonnentor 2  
D-99098 Erfurt  
☎ +49 (0) 361 26 280-0  
☎ +49 (0) 361 26 280-175  
✉ info@qundis.com  
**www.qundis.com**